

KASK KL-2

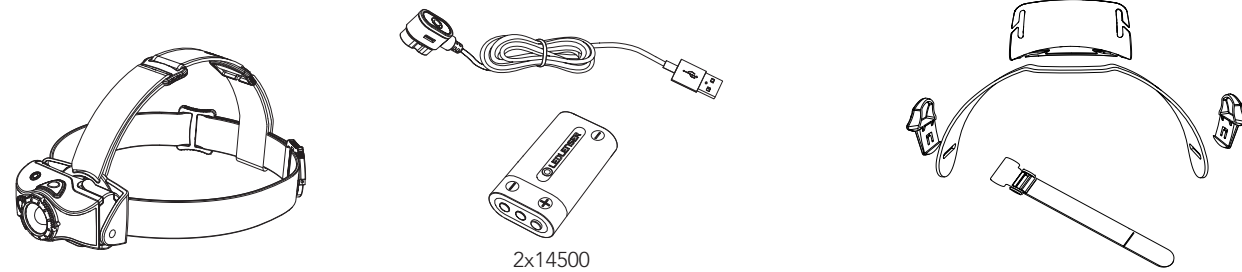

2x14500

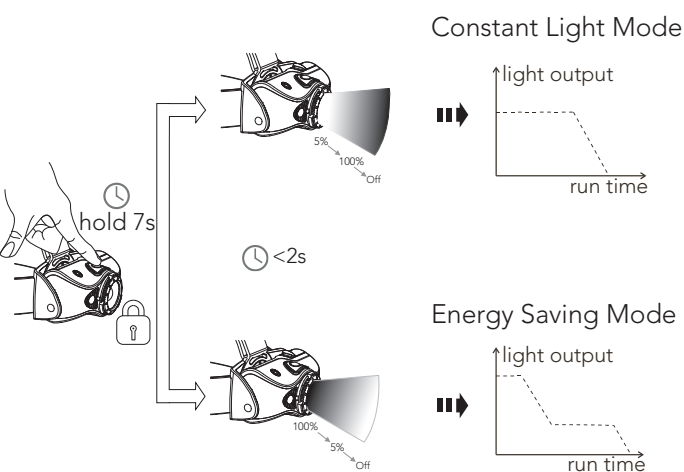
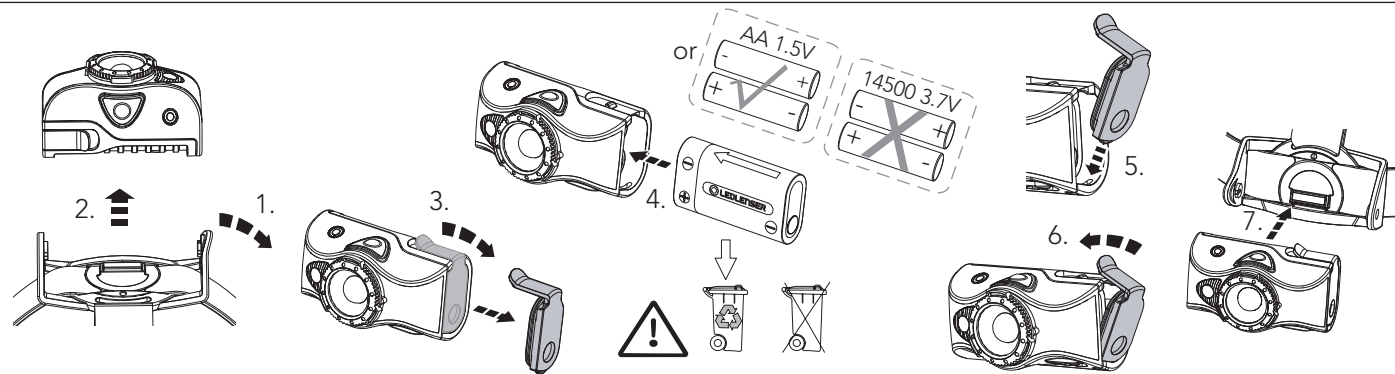

Constant Light Mode

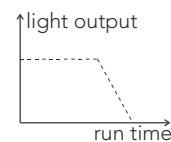

Energy Saving Mode

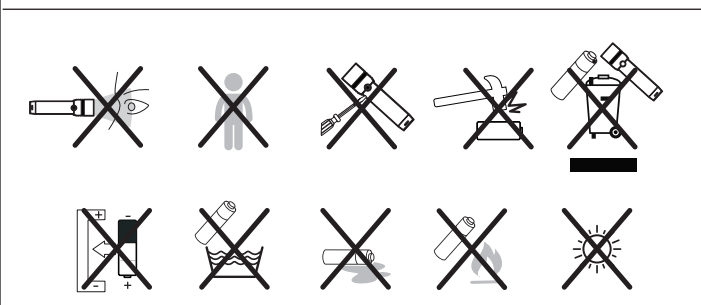
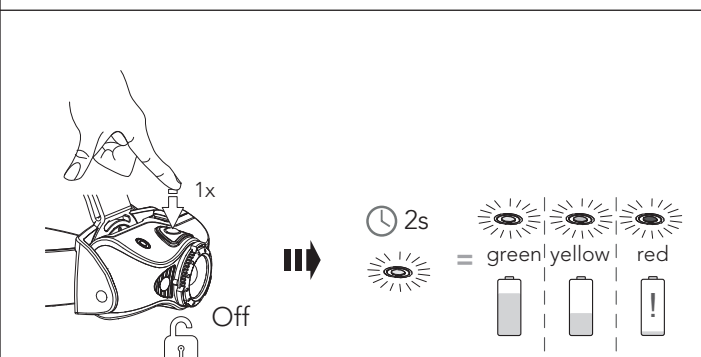
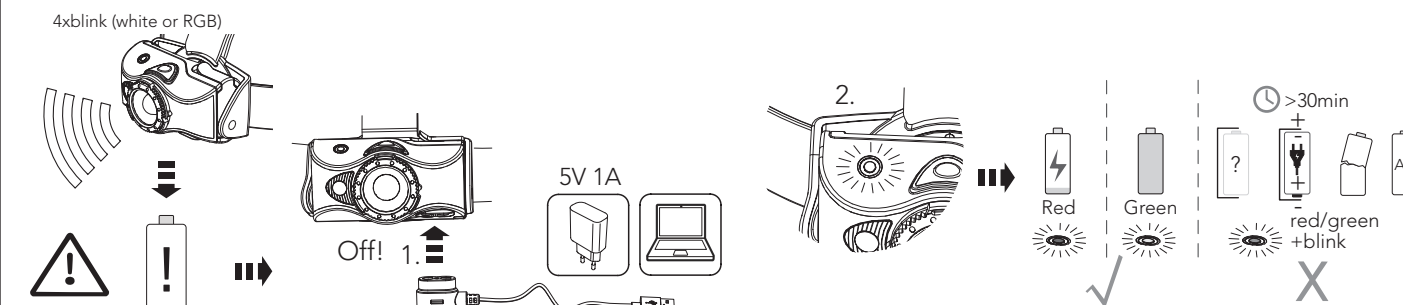
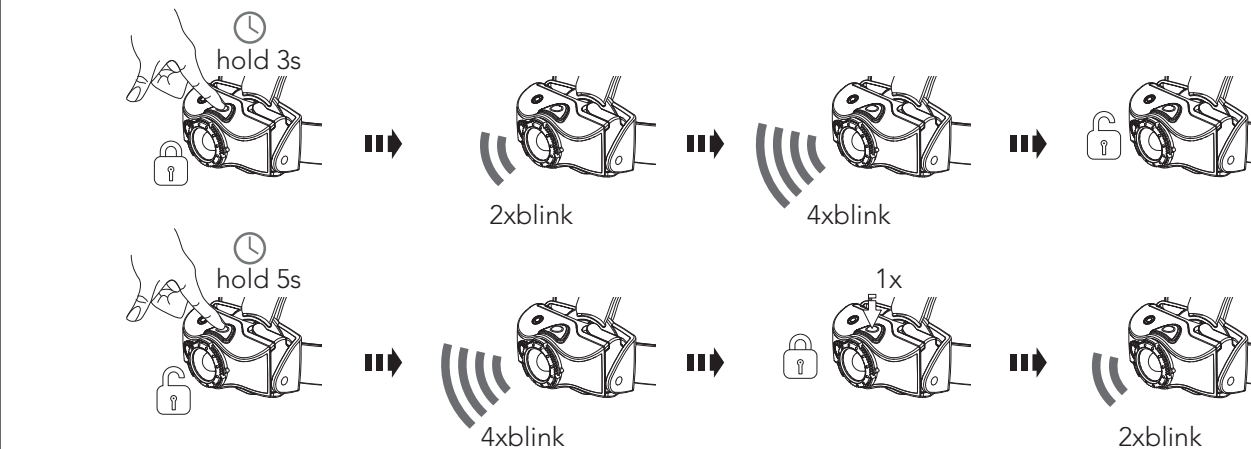
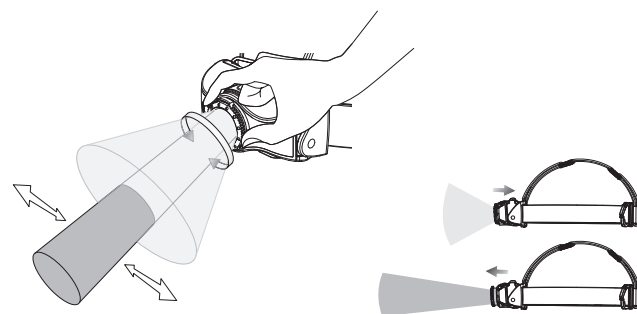
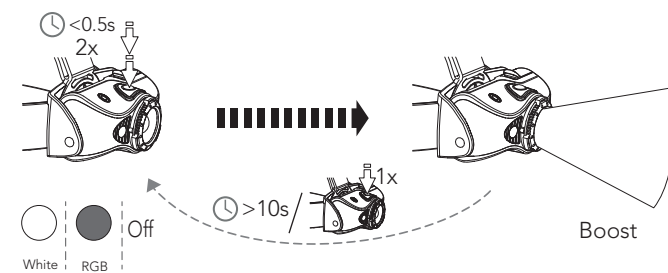
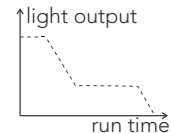

KASK S.p.A.
 24060 Chiuduno, BG - Via Firenze, 5 - Italy
 t. +39 035 4427497 - info@kask.com - www.kask.com



KL2_QUG_V0.1
 28.07.2020
 1J12A0412

KASK KL-2

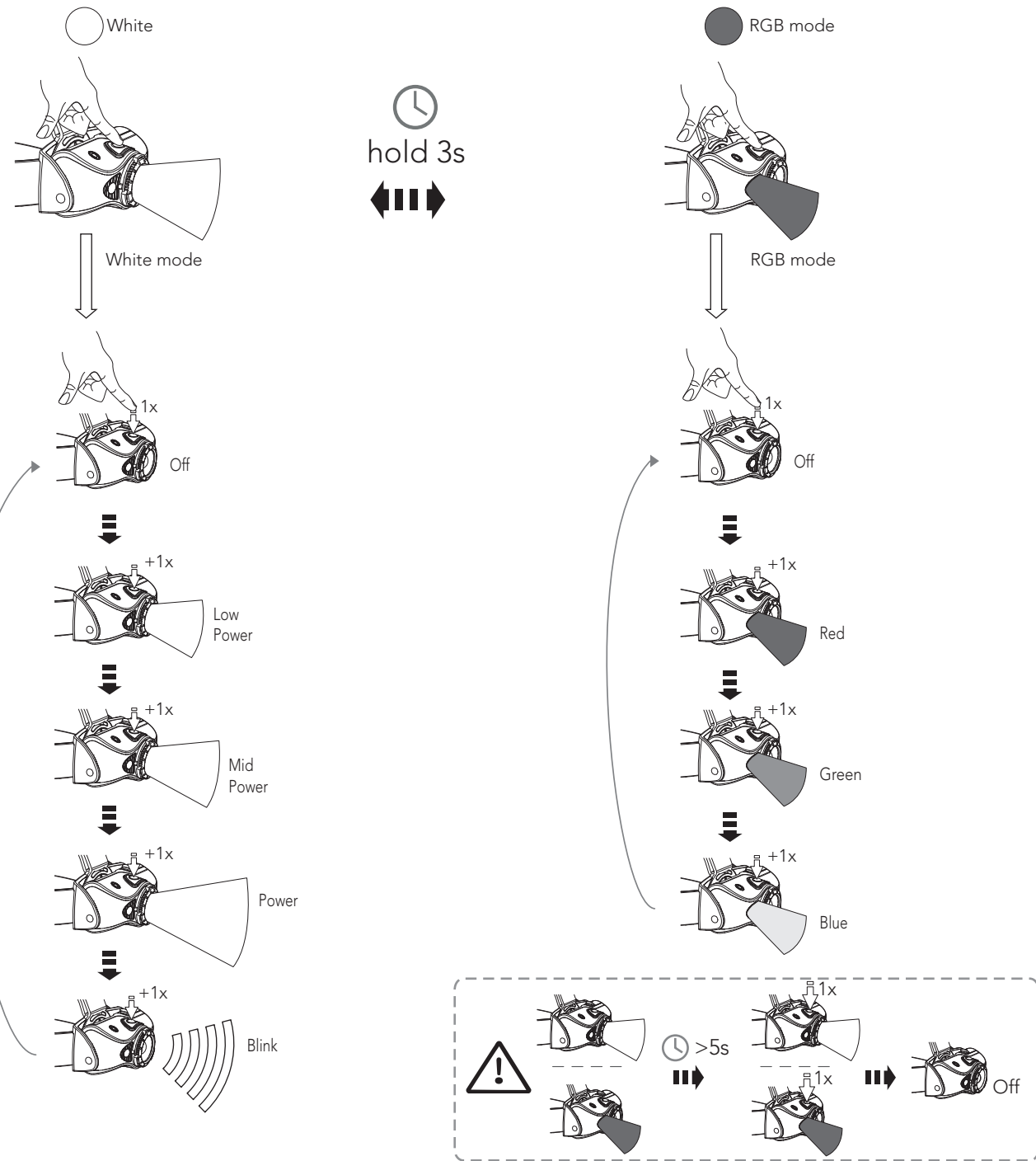

HELMET OVERHEAD BAND SET

